

D₈

Restorative / Stomatologia zachowawcza

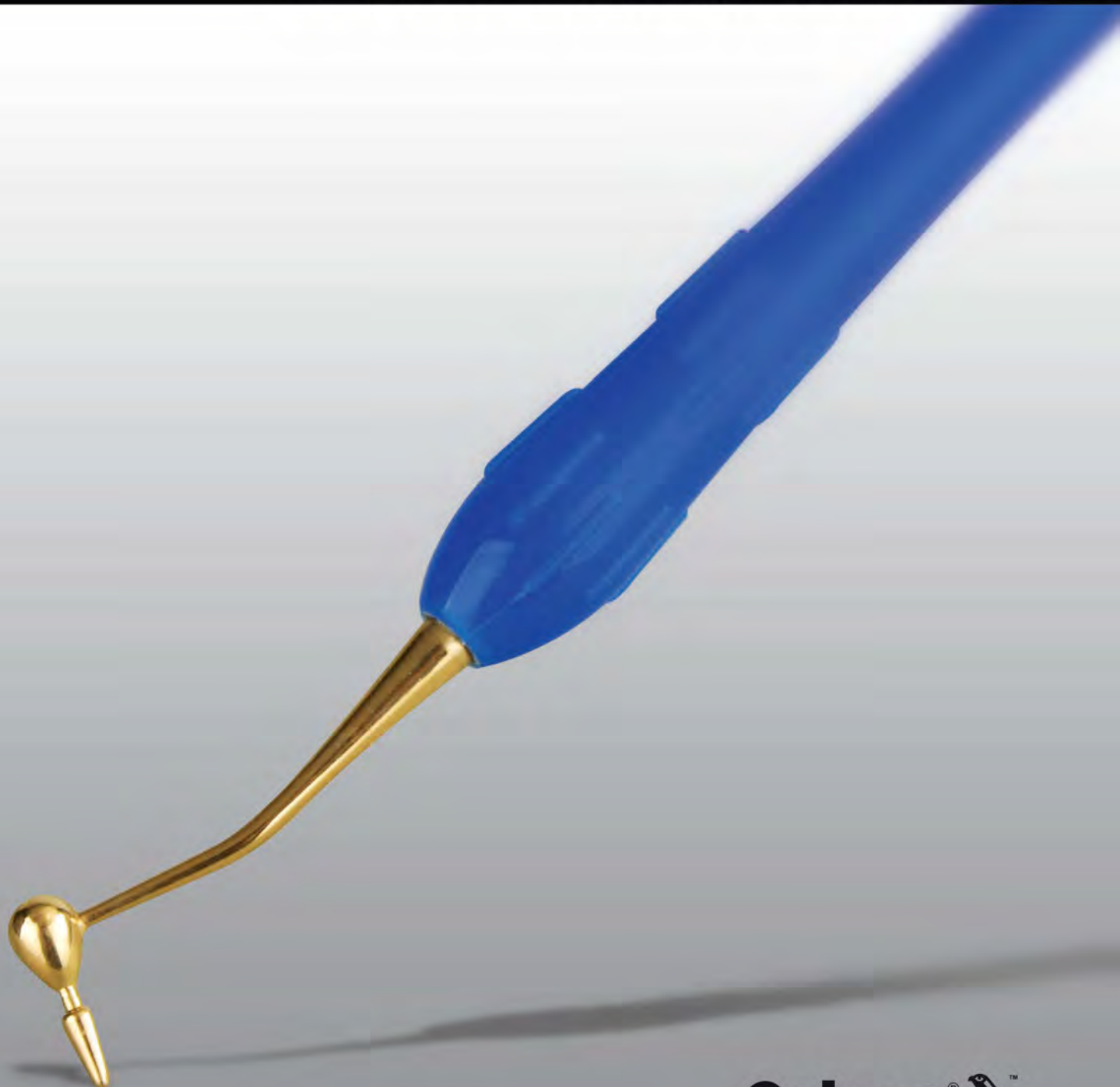

Compo-fill Instruments

Easy
COLOR



Ultra Light weight
Non-stick tips
TIN coated

Bardzo lekkie
Końcówki "Non-Stick"
Pokryte azotkiem tytanu



Autoclavable
Możliwość sterylizacji w autoklawie

Silicone handle with Aluminum core
Uchwyt silikonowy z rdzeniem aluminiowym

Pluggers / Przenośniki



Fig. 5A DR.051.051



Fig. 3 DR.073.031 Hollenback



Fig. 1 DR.091.011 Super



Fig. 0T DR.092.001 Tanner



Fig. 0/1 DR.063.011 Black



Fig. 1/2 DR.063.021 Black

Burnishers / Upychadła



Fig. 21B DR.111.211 Acorn/ Wescott



Fig. 1 DR.121.011 Contact Former



Fig. 2 DR.121.021 Contact Former



Fig. 2 DR.139.021 Ladmore

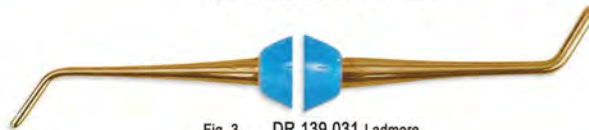

Fig. 3 DR.139.031 Ladmore



Fig. 27/29 DR.148.041 White



Fig. 1 DR.100.011



Fig. 1L DR.101.011



Fig. 155 DR.135.551

Filling instruments / Nakładacze



Autoclavable
Możliwość sterylizacji w autoklawie

Easy
COLOR



Fig. 156(A6) DR.426.561



Fig. 8A DR.431.081



Fig. 1 DR.445.011 Boghosian



Fig. 2 DR.445.021 Boghosian



Fig. 1 DR.451.011 Falcon



Fig. 2 DR.451.021 Falcon



Fig. 1 DR.457.011 Goldstein



Fig. 2 DR.457.021 Goldstein



Fig. 3 DR.457.031 Goldstein



Fig. 4 DR.457.041 Goldstein



Fig. 1 DR.458.011 Goldstein-Mini



Fig. 3 DR.458.031 Goldstein-Mini



Fig. 4 DR.458.041 Goldstein-Mini



Fig. 1 DR.459.011 Goldstein-Micro



Fig. 4/5 DR.460.051 Gregg



Fig. 0 DR.463.001 Heidemann



Fig. 1 DR.463.011 Heidemann



Fig. 2 DR.463.021 Heidemann



Fig. W3 DR.513.031



Fig. 1 DR.425.011



Fig. 6 DR.425.061



Fig. 178 DR.426.781



Fig. 49 DR.440.491



Fig. 179 DR.440.791



Compo-fill Instruments TIN coated
Compo-fill Instrumenty pokryte azotkiem tytanu

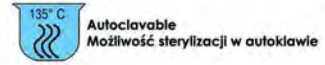

Pluggers / Przenośniki



Fig. 1/2 DR.063.025T Black



Fig. 1 DR.091.015T Super



Fig. 3 DR.073.035T Hollenback



Fig. 0T DR.092.005T Tanner

Burnishers / Upychadła



Fig. 21B DR.111.215T Acorn/Wescott



Fig. 3 DR.139.035T Ladmore



Fig. 1 DR.121.015T Contact former



Fig. 27/29 DR.148.045T White

Filling Instruments / Nakładacze



Fig. 1 DR.425.015T



Fig. 1 DR.457.015T Goldstein



Fig. 6 DR.425.065T



Fig. 2 DR.457.025T Goldstein



Fig. 156 (A6) DR.426.565T



Fig. 4 DR.458.045T Goldstein-mini



Fig. 178 DR.426.785T



Fig. 4/5 DR.460.055T Gregg



Fig. 49 DR.440.495T



Fig. 2 DR.463.025T Heidemann



Fig. 2 DR.451.025T Falcon



Fig. W3 DR.513.035T



TIN coated / Pokryte azotkiem tytanu

135°C Autoclavable
Możliwość sterylizacji w autoklawie

Burnishers / Upychadła

Classic Round

6 mm solid handle
6 mm pełny uchwyt

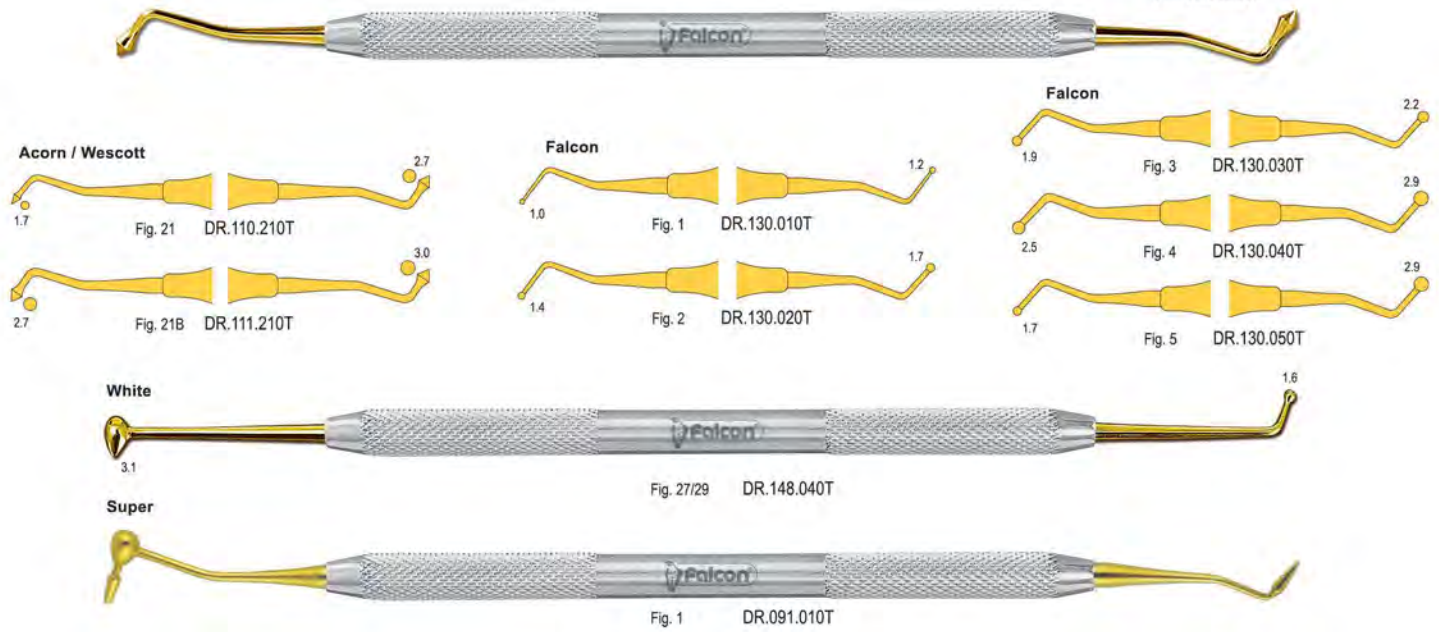

135°C Autoclavable
Możliwość sterylizacji w autoklawie

Filling instruments / Nakładacze

Classic Round

6 mm solid handle
6 mm pełny uchwyt

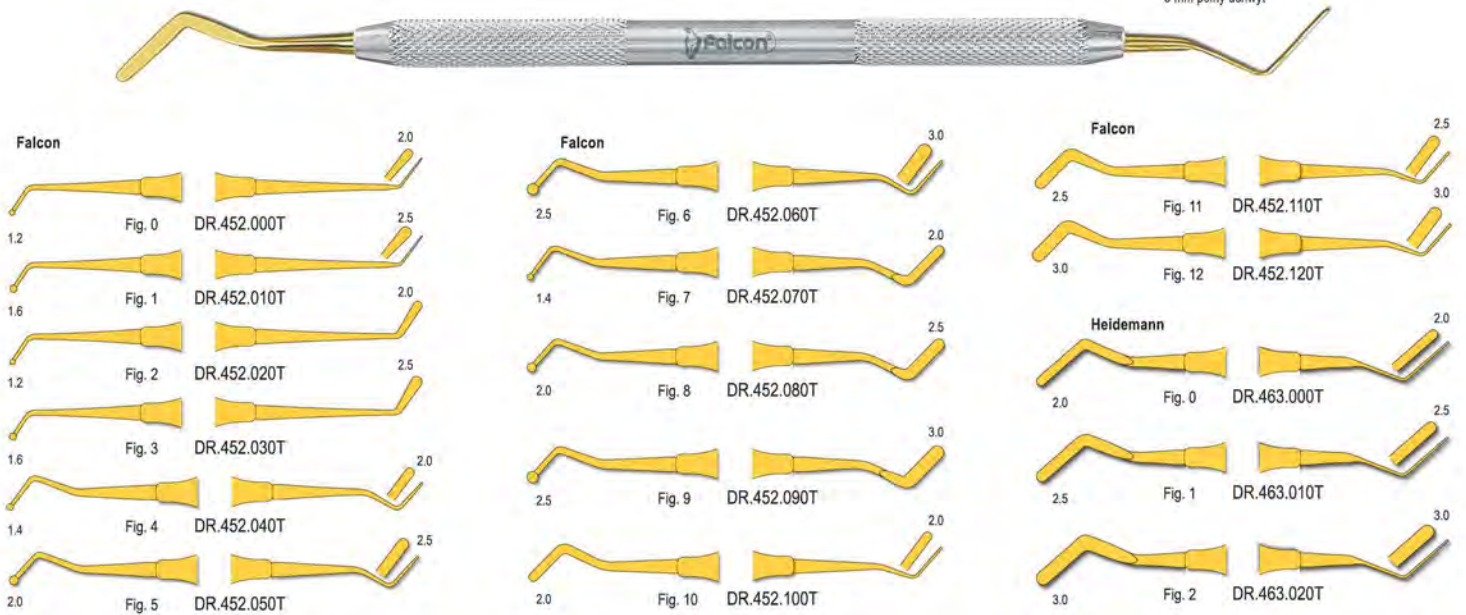

135°C Autoclavable
Możliwość sterylizacji w autoklawie

Plastic amalgam carriers / Pistolet do amalgamatu plastikowe



PP011/0041
Right angled
Zagięty pod kątem



PP011/004
Curved
Zagięty



Amalgam carriers / Pistolety do amalgamatu

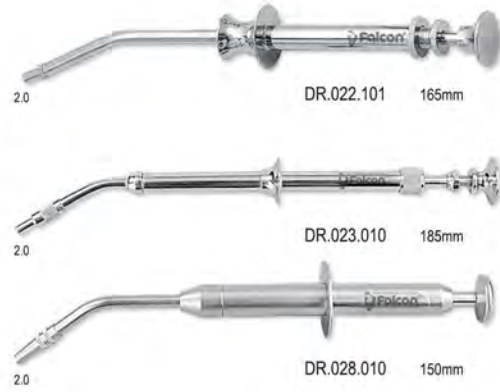
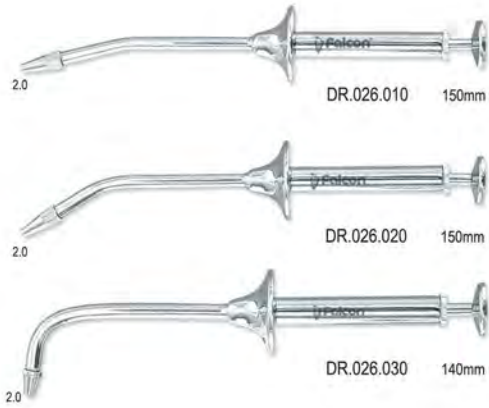

Amalgam guns / Pistolety do amalgamatu

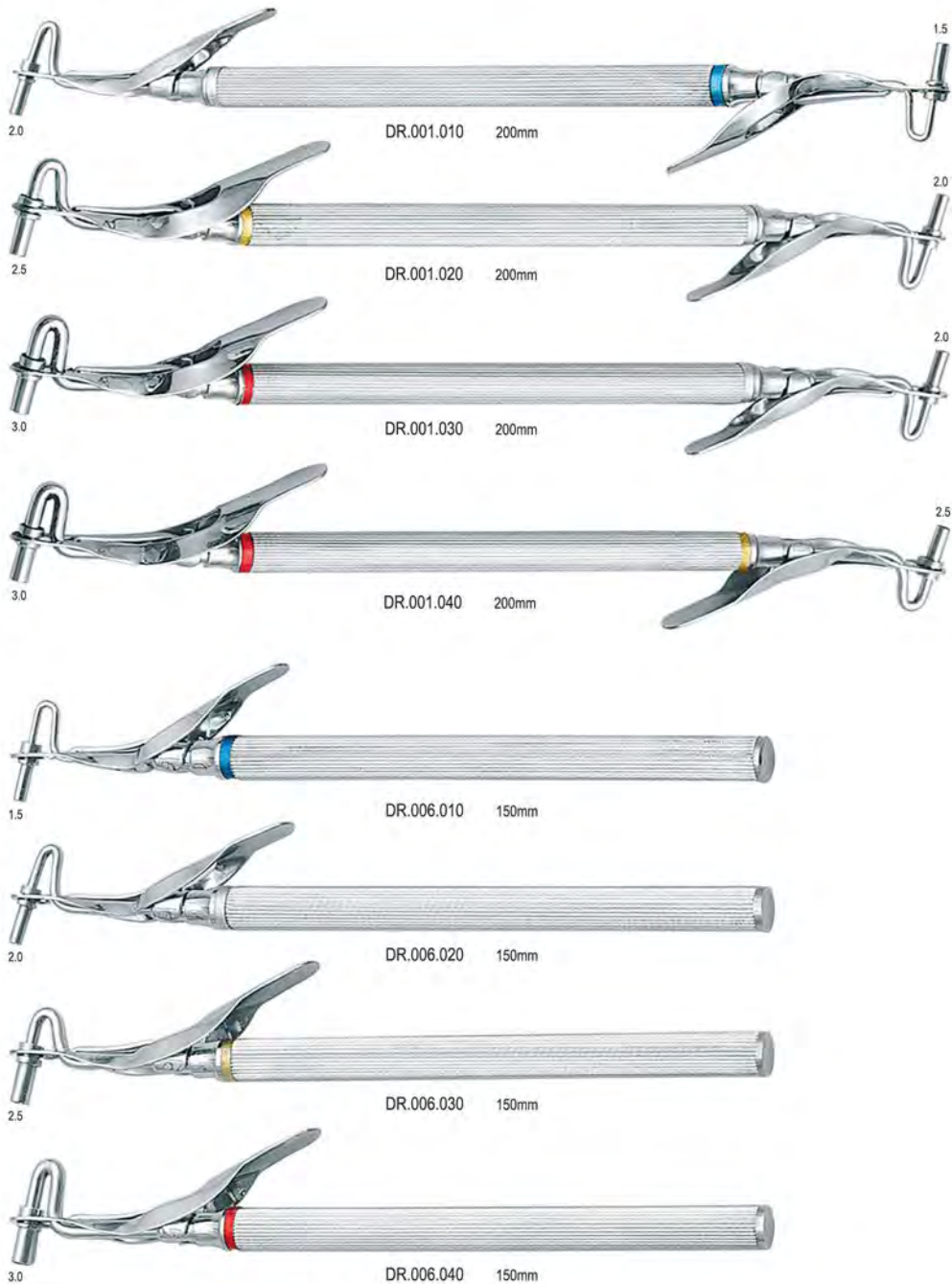

Amalgam well / Miseczka do amalgamatu



DR.098.010
Autoclavable
Możliwość sterylizacji w autoklawie

Amalgam gun for micro filling
Pistolet do amalgamatu do mikro wypełnień



Ø 1.2 mm
DR.024.020 Straight / Prosty
DR.024.030 Curved / Zagięty
130 mm

Pluggers
Przeñośniki



SOFT LINE INSTRUMENTS
soft and sure grip

135° C Autoclavable
Możliwość sterylizacji w autoklawie

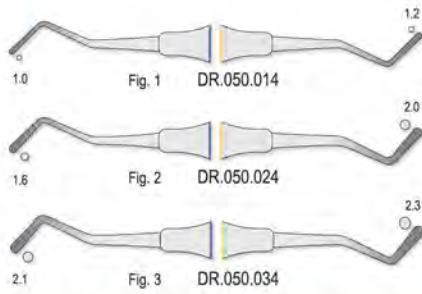

Standard
Serrated / ząbkowane

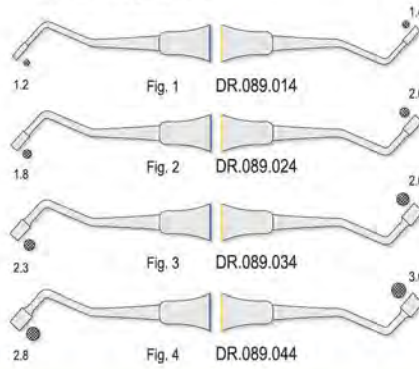

Markley
Plain / bez ząbków

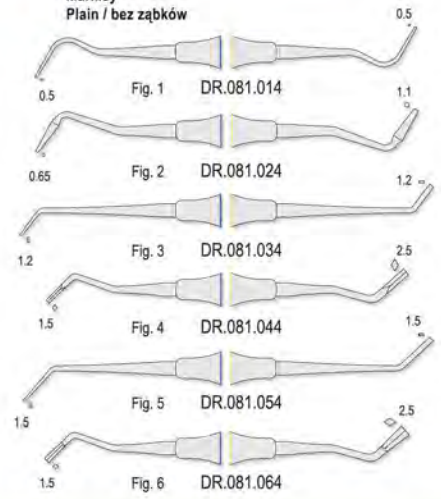

Super plugger / Przeñośnik Super



Fig.1 DR.091.014

Pluggers / Przeñośniki

Classic-8
5.5 mm solid handle
5.5 mm pełny uchwyt



DR.091.017

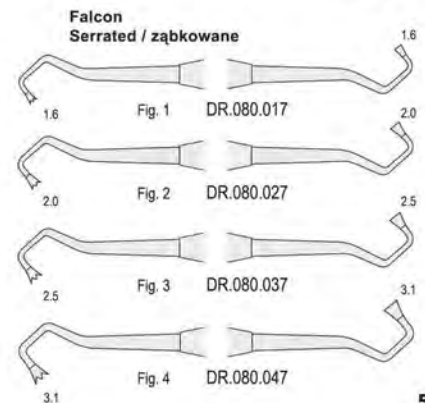
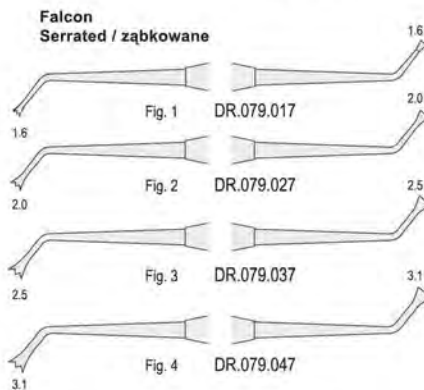
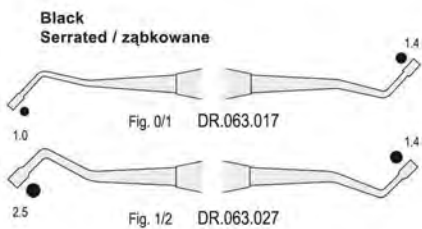



Pluggers / Przenośniki

Classic Round

6 mm solid handle
6 mm pełny uchwyt

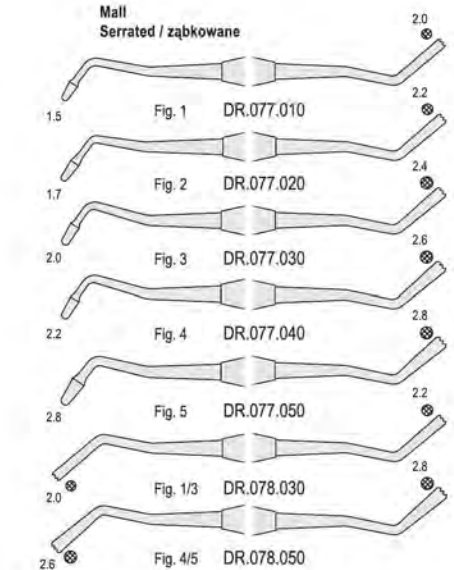
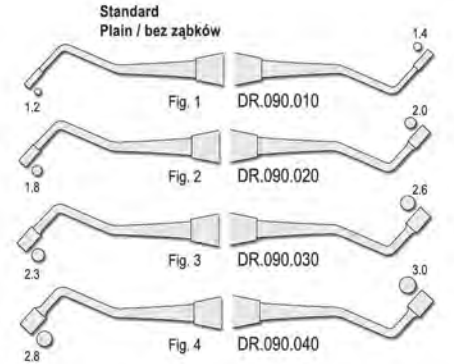
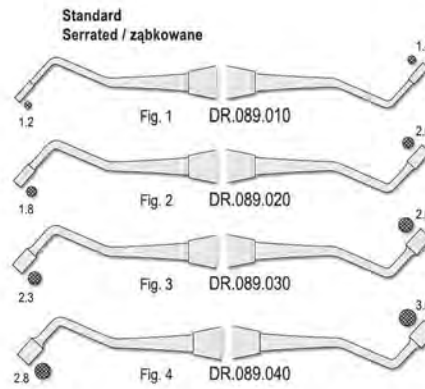
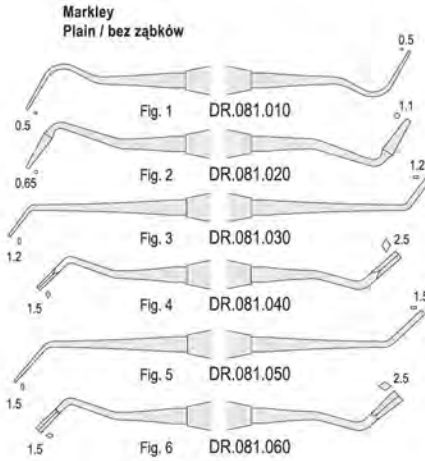
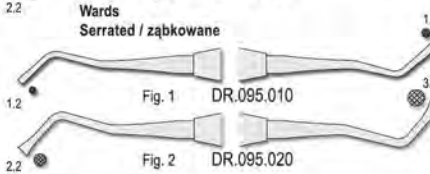
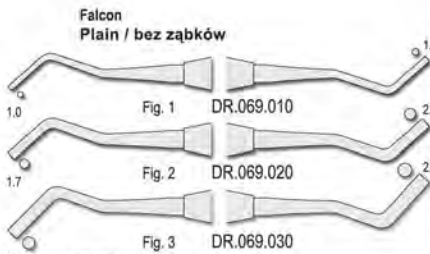
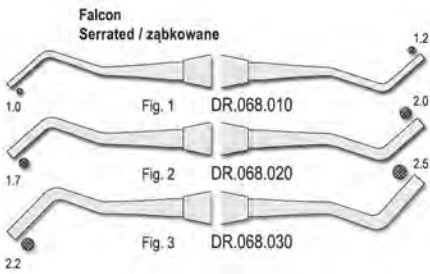
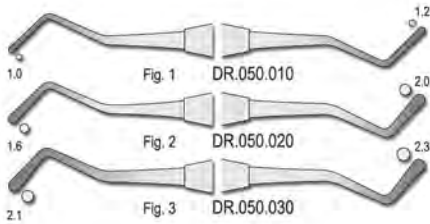

Burnishers / Upychadła

SOFT LINE INSTRUMENTS
soft and sure grip

135°C Autoclavable
Możliwość sterylizacji w autoklawie

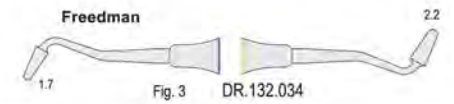
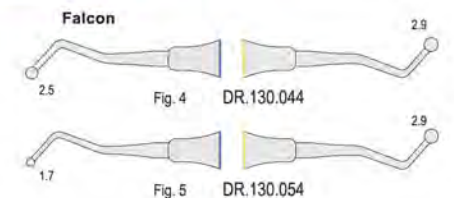
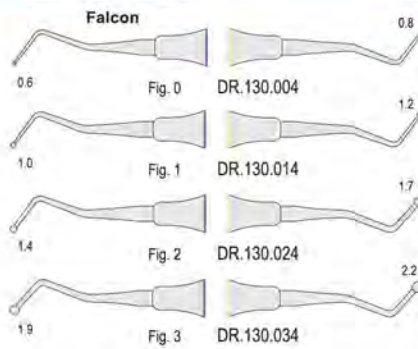
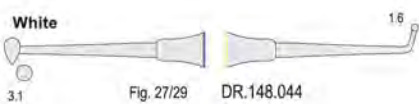
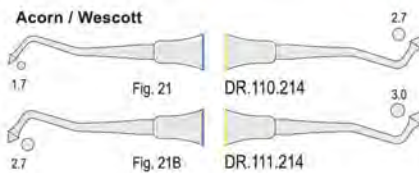

Burnishers / Upychadła

CLASSIC-LITE

10 mm hollow handle
10 mm pusty uchwyt



Acorn / Wescott



Falcon



Falcon

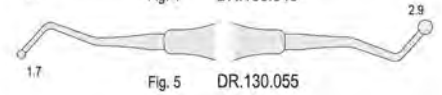

White

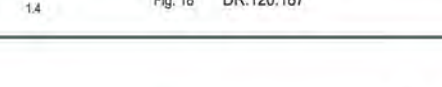
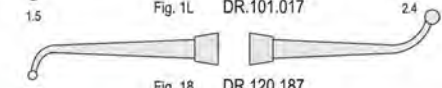
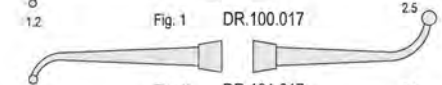
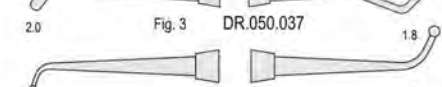
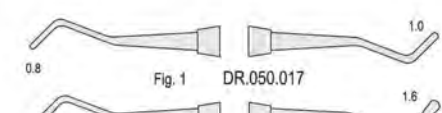
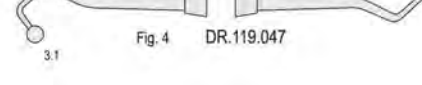
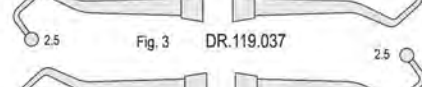
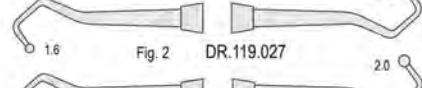
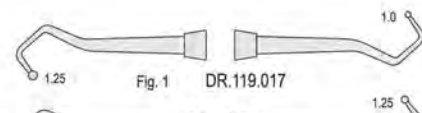
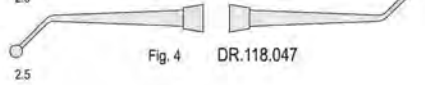
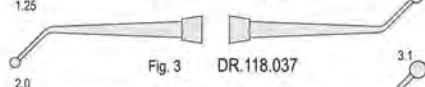
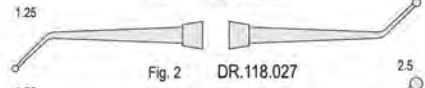
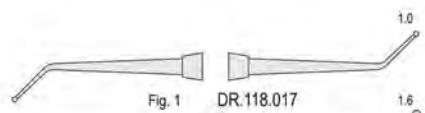

Fig. 27/29 DR.148.045

Burnishers / Upychadła

Classic-8

5.5 mm solid handle
5.5 mm pełny uchwyt



Burnishers / Upychadła

Classic-Round

6 mm solid handle
6 mm pełny uchwyt

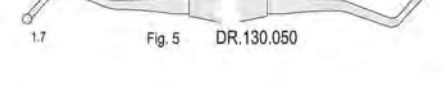
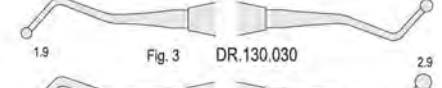
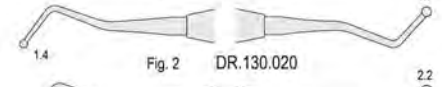
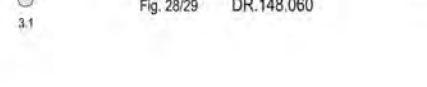
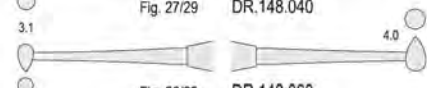
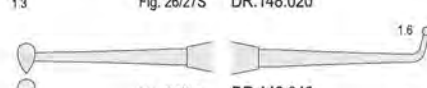
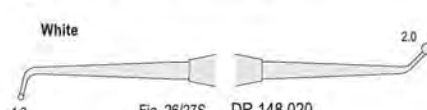
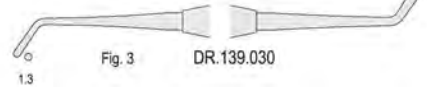
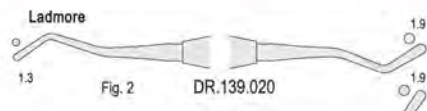
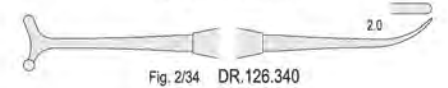
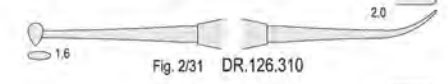
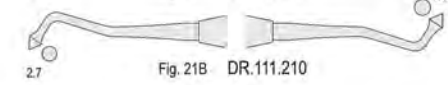
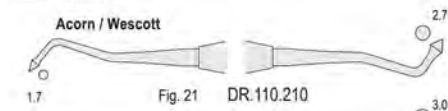



Filling instruments
Nakładacze



Autoclavable
Możliwość sterylizacji w autoklawie

SOFT LINE INSTRUMENTS
soft and sure grip

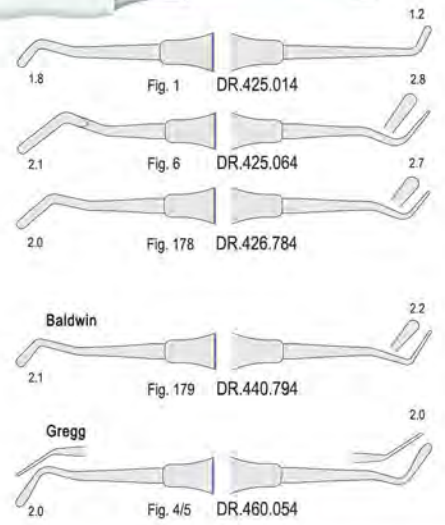
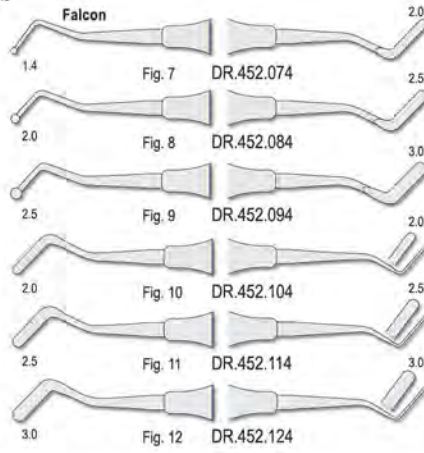
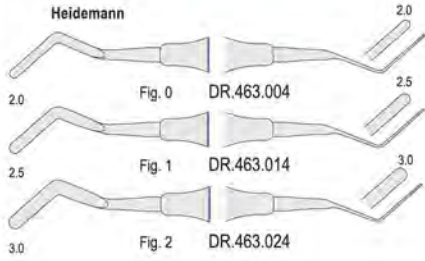

Filling instruments
Nakładacze

Classic-8
5.5 mm solid handle
5.5 mm pełny uchwyt

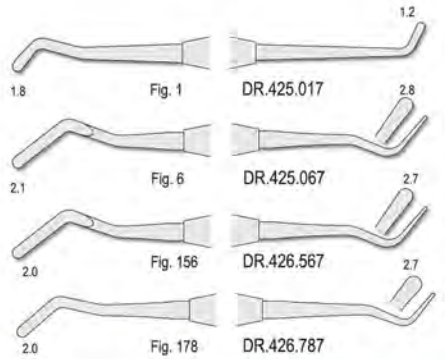
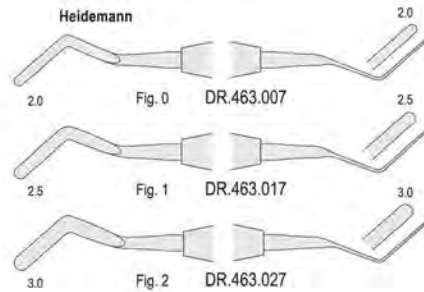
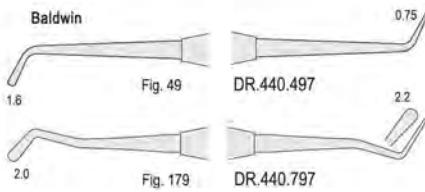

Filling instruments
Nakładacze

CLASSICLITE
10 mm hollow handle
10 mm pusty uchwyt

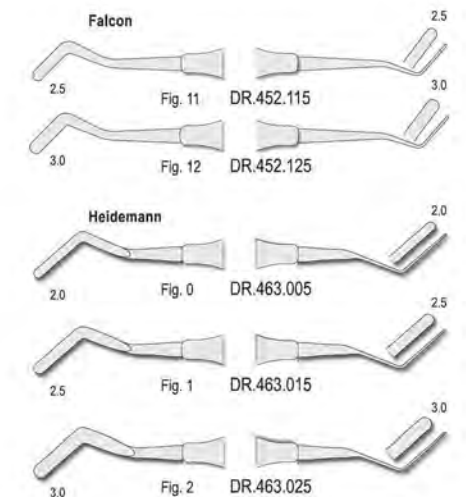
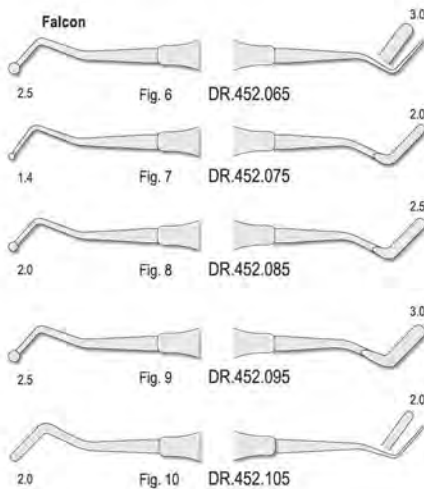
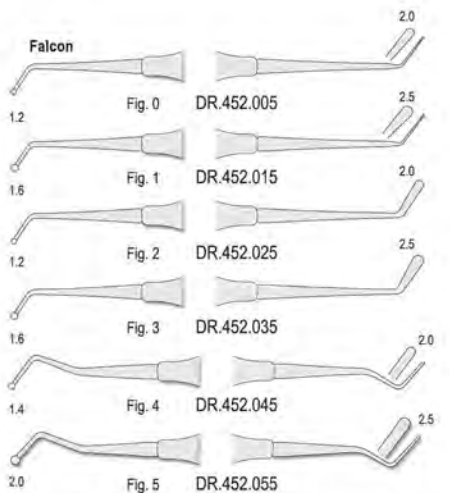

Filling instruments
Nakładacze

Classic Round
6 mm solid handle
6 mm pełny uchwyt

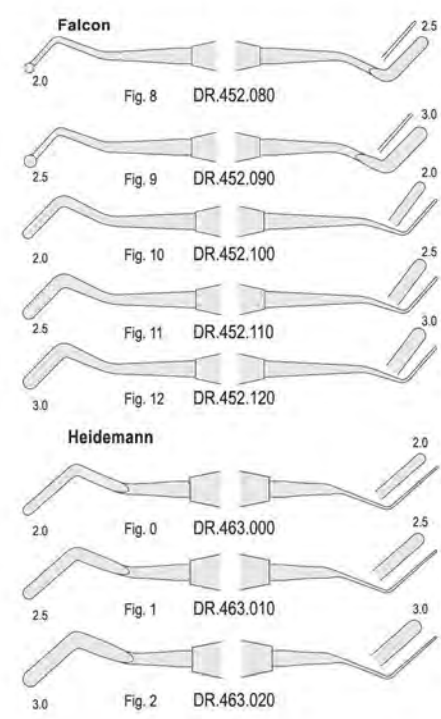
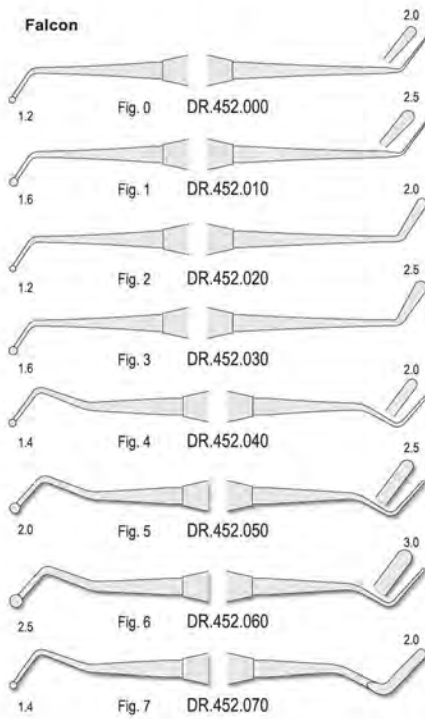
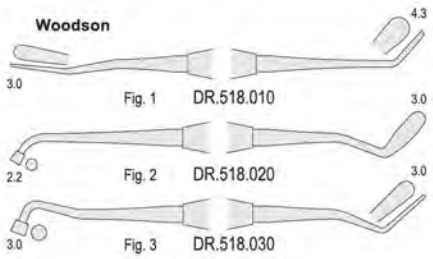
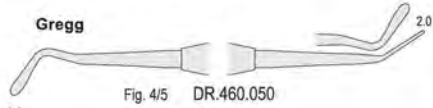
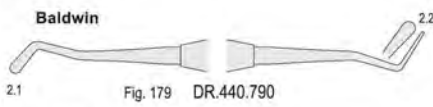
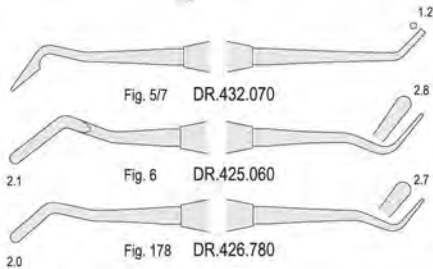

Cement spatulae
Łopatki do cementu

SOFT LINE INSTRUMENTS
soft and sure grip

 135° C Autoclavable
Możliwość sterylizacji w autoklawie



Cement spatulae
Łopatki do cementu

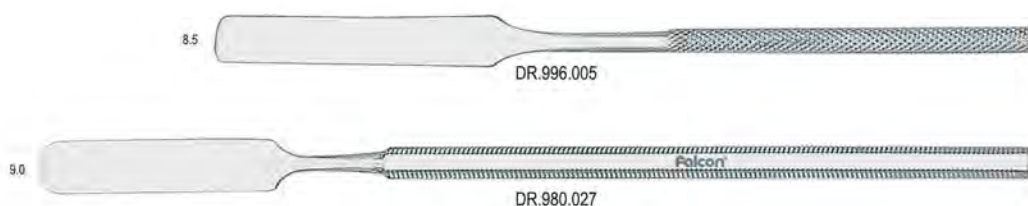



Restorative Stomatologia zachowawcza

Cement spatulae Łopatki do cementu

Classic-Round
6 mm solid handle
6 mm pełny uchwyt



Cement spatulae Łopatki do cementu

Classic-8
5.5 mm solid handle
5.5 mm pełny uchwyt



Glass slabs Płytki do cementu



A mm	B mm	C mm	Code Kod
95	70	5	DR.998.010
120	80	5	DR.998.020
150	80	12	DR.998.030

Mixing pads Bloczki papierowe do mieszania



DENTALINE®

DZ.458.010	50 x 50 mm
DZ.458.020	75 x 75 mm
DZ.458.030	75 x 125 mm
DZ.458.040	100 x 140 mm
DZ.458.050	140 x 180 mm

Excavators Wydrążacze / Ekskawatory

SOFT LINE INSTRUMENTS
soft and sure grip



135° C
Autoclavable
Możliwość sterylizacji w autoklawie

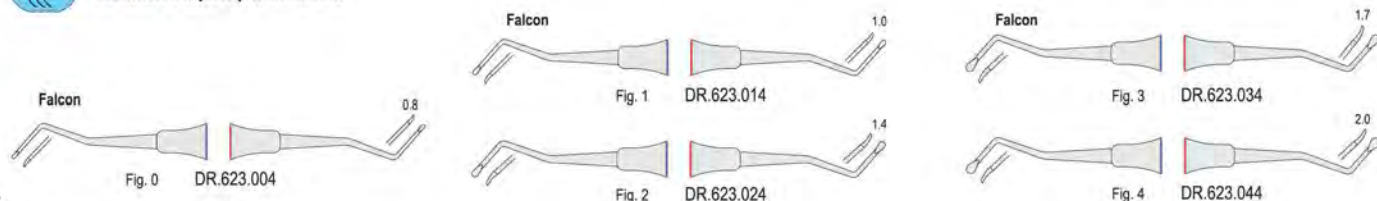

Excavators
Wydrążacze / Ekskawatory

Classic Round
6 mm solid handle
6 mm pełny uchwyt

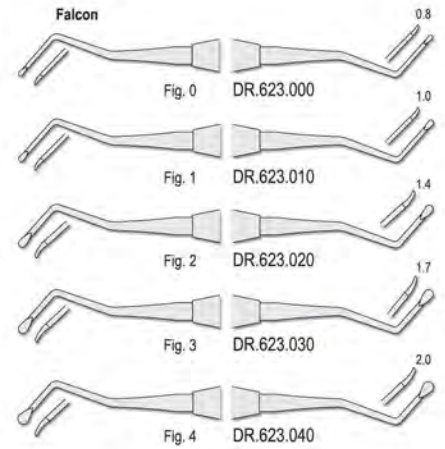
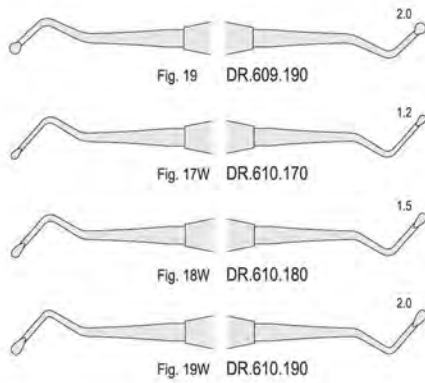
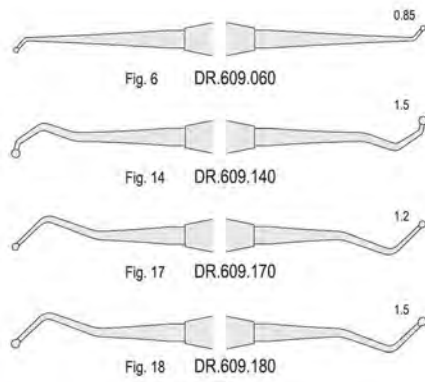

Excavators
Wydrążacze / Ekskawatory

Classic 8
5.5 mm solid handle
5.5 mm pełny uchwyt

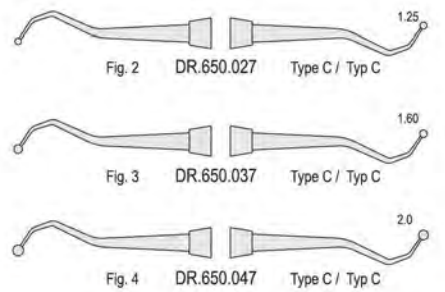
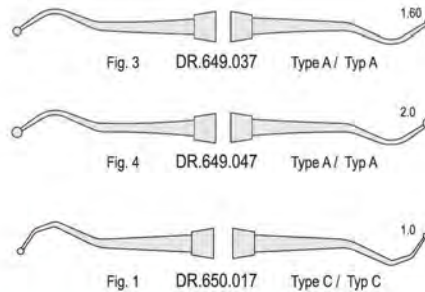
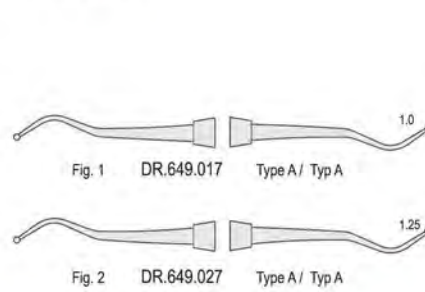

Finishing knives
Nożyki do modelowania kompozytu

 135° C Autoclavable
Możliwość sterylizacji w autoklawie

SOFT LINE INSTRUMENTS
soft and sure grip



Fig. 2 DR.297.024 USC

Fig. 2S DR.298.024 USC



Cavity preparation instruments
Wydrążacze / Ekskawatory



Classic-Found

6 mm solid handle
6 mm pełny uchwyt

Blacks

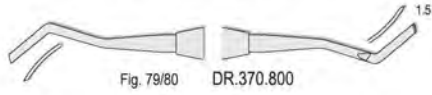
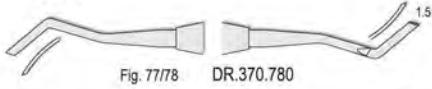

Ferrier



Ferrier



Carvers

Nożyki do modelowania



Classic-Found

6 mm solid handle
6 mm pełny uchwyt

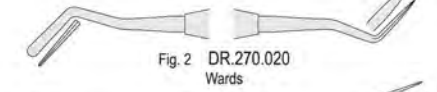
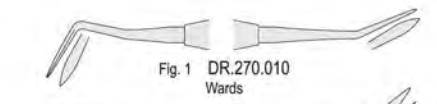
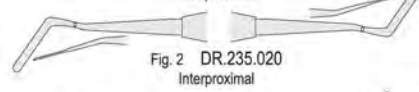
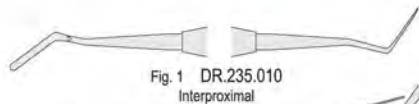
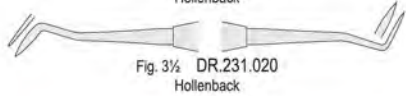
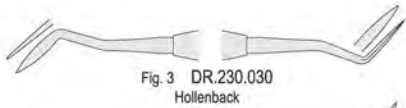

Carvers

Nożyki do modelowania



SOFT LINE INSTRUMENTS
soft and sure grip



Finishing knives / Nożyki do modelowania kompozytu

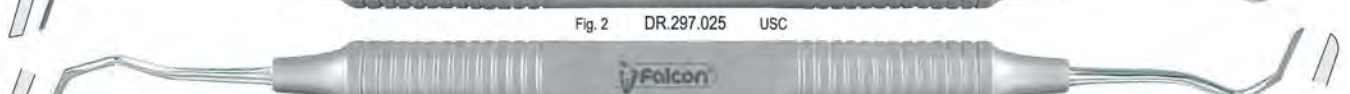

CLASSIC-LITE

10 mm hollow handle
10 mm pusty uchwyt

Cleoid-Discoid
Cleoid-Discoid



Classic-Found

6 mm solid handle
6 mm pełny uchwyt



Cleoid-Discoïd
Cleoid-Discoïd

SOFT LINE INSTRUMENTS
soft and sure grip

135° C
Autoclavable
Możliwość sterylizacji w autoklawie

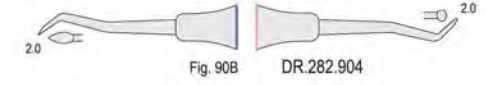
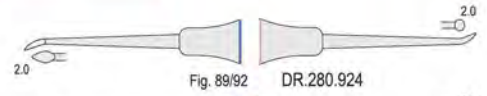

Filling removing instrument
Instrument do usuwania wypełnienia



Fig. 1 DR.527.014



Fig. 4 DR.527.045

Applicators for calcium hydroxide
Aplikatory do dycal



Applicator for medicaments
Aplikator do leków



DR.873.017
Orban

Serie-UNO
Economical dental instruments
Instrumenty stomatologiczne w atrakcyjnej cenie

135° C
Autoclavable
Możliwość sterylizacji w autoklawie



Pluggers / Przenośniki

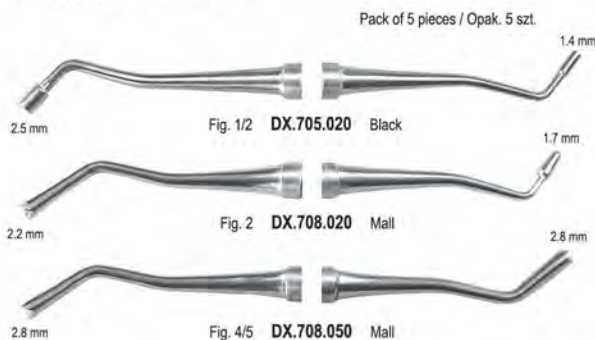

Burnishers / Upychadła





Serie-UNO

**Economical dental instruments
Instrumenty stomatologiczne w atrakcyjnej cenie**



Autoclavable
Możliwość sterylizacji w autoklawie



Filling instruments / Nakładacze

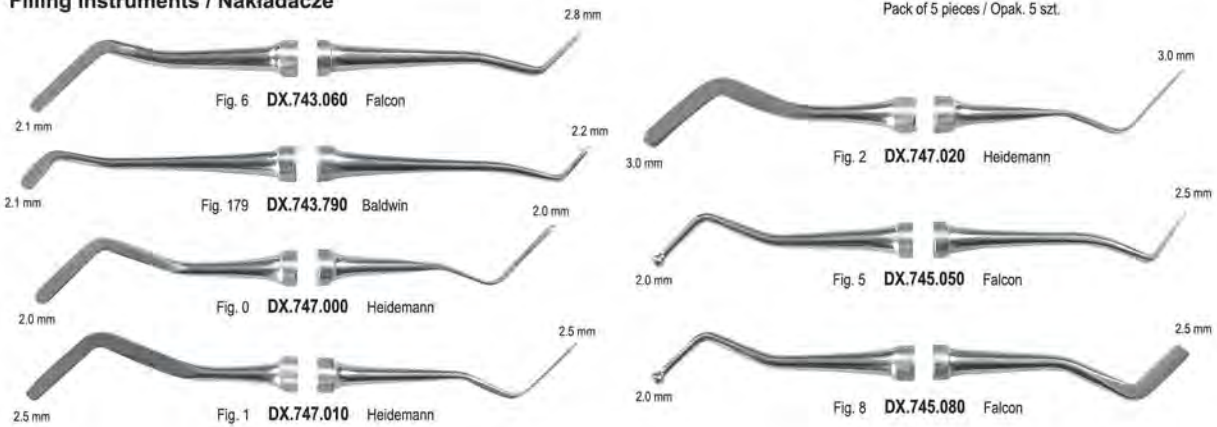

Cement spatula / Łopatka do cementu



**Automatic crown and bridge remover
Zbijak do koron samopowtarzalny**

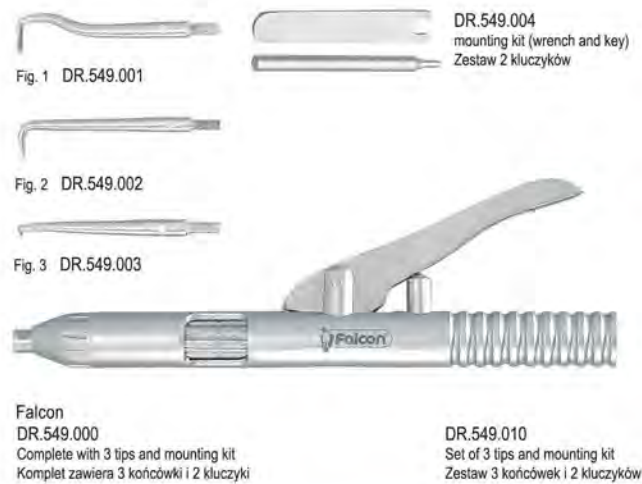

**Semi-automatic crown and bridge remover
Zbijak do koron trzystopniowy**



**Manual crown remover double ended
Zbijak do koron ręczny dwustronny**



**Manual crown remover
Zbijak do koron ręczny**



Manual crown remover
Zbijak do koron ręczny



Fig. 1 DR.559.001

Fig. 2 DR.559.002

Fig. 3 DR.559.003

Morrel
DR.559.000
Complete with 3 tips
Komplet zawiera 3 końcówki

DR.559.010
Set of 3 tips
Zestaw 3 końcówek

Manual crown remover with spring
Zbijak do koron ręczny ze sprężyną



Fig. 1 DR.559.001

Fig. 2 DR.559.002

Fig. 3 DR.559.003

Morrel
DR.560.000
Complete with 3 tips
Komplet zawiera 3 końcówki

DR.560.010
Set of 3 tips
Zestaw 3 końcówek

Manual crown remover double ended
Zbijak do koron ręczny dwustronny



Fig. 1 DR.554.001

Fig. 2 DR.554.002

Fig. 3 DR.554.003

Falcon
DR.554.000
Complete with 3 tips
Komplet zawiera 3 końcówki

DR.554.010
Set of 3 tips
Zestaw 3 końcówek

Crown pliers
Kleszce do koron



DR.531.160
Wynman-Falcon
160 mm
With Tungsten Carbide inserts
z wkładką z węgliku spiekanego



DR.532.160
Wynman-Falcon
160 mm
With Tungsten Carbide inserts
z wkładką z węgliku spiekanego

Temporary crown removing pliers
Kleszce do zdejmowania tymczasowe koron



DR.535.010
Set of 10 tips
Zestaw 10 końcówek

DR.535.000
155mm
Complete with 10 tips
Komplet zawiera 10 końcówek



DR.539.010
Furrer
160 mm



**Restorative
Stomatologia zachowawcza**

**Crown spreaders
Rozwieracze do koron**



**Crown spreaders
Rozwieracze do koron**



**Manual crown remover / Crown spreaders
Rozwieracze do koron**



**Forceps for articulating paper
Pensety do kalki**





Contoured anatomical matrices
Paseki anatomiczne do formówek

Pack of 30 pieces / Opak. 30 sztuk
Grubość 0.05 mm



DR.811.010
Premolars left
Przedtrzonowce lewe



DR.811.020
Premolars right
Przedtrzonowce prawe



DR.811.030
Molars left
Trzonowce lewe



DR.811.040
Molars right
Trzonowce prawe



DR.811.050
Premolars left, right
Przedtrzonowce obustronne



DR.811.060
Molars left, right
Trzonowce obustronne



DR.811.000
Assorted
Asortyment

Matrix bands
Paski do formówek

Thickness / Grubość
0.04 mm



DR.799.050 5 mm
DR.799.060 6 mm
DR.799.070 7 mm
Length / Długość 10 m

Thickness / Grubość
0.05 mm



DR.800.050 5 mm
DR.800.060 6 mm
DR.800.070 7 mm
Length / Długość 10 m

Ivory
Pack of 12 pieces
Opak. zawiera 12 szt.



Fig. 11 DR.806.010
for children / dziecięce



Fig. 12 DR.806.020
for children / dziecięce



Fig. 14 DR.805.010
small / małe



Fig. 15 DR.805.020
medium / średnie



Fig. 16 DR.805.030
large / duże

Nyström
Pack of 12 pieces
Opak. zawiera 12 szt.



Fig. 2 DR.808.020
premolars / przedtrzonowce



Fig. 4 DR.808.040
molars / trzonowce



Fig. 5 DR.808.050
molars / trzonowce



Fig. 6 DR.808.060
premolars / przedtrzonowce



Fig. 7 DR.808.070
molars / trzonowce

Tofflemire
Pack of 12 pieces
Opak. zawiera 12 szt.



Fig. 101 DR.810.101



Fig. 102 DR.810.102

Polyester matrix band
Taśma poliestrowa gładka



DR.1100.50 8mm x 0.05mm
DR.1100.80 8mm x 0.75mm

15 mb ± 5 cm Length / Długość



Matrix retainers
Formówki



5 mm
DR.829.050
Falcon



DR.840.010
Tofflemire-Junior



5 mm
DR.830.085
Ivory



DR.840.020
Tofflemire-Senior



Fig. 12
DR.830.120
Ivory



6 mm
DR.830.086
Ivory



DR.840.030
Tofflemire-Universal



7 mm
DR.830.087
Ivory



Left / Lewa
DR.832.010
Nystrom



DR.855.010
Matrix clamp
Zacisk do pasków



Fig. 12A
DR.830.121
Ivory



Right / Prawa
DR.832.020
Nystrom

Matrix forceps
Kleszce do formówek pierścieniowych



Falcon
DR.820.170
170 mm



Latex rubber dam
Koferdam z lateksu



Green / Zielony
150 x 150 mm
36 sheets / 36 szt.

DR.899.010
0.14
Thin / Cienki

DR.899.020
0.18
Medium / O średniej grubości

DR.899.030
0.22
Heavy / Gruby

Rubber dam clamps
Klamry do koferdamu

Premolars / do zębów przedtrzonowych

Fig. 00 DR.907.000 Fig. 0 DR.907.001 Fig. 2 DR.907.020 Fig. 2A DR.907.021

Molars / do zębów trzonowych

Fig. 7 DR.907.070 Fig. 8 DR.907.080 Fig. 8A DR.907.081 Fig. 14 DR.907.140 Fig. 14A DR.907.141

Anteriors / do zębów przednich

Fig. 211 DR.907.211 Fig. 212 DR.907.212

TRUE FLEX RUBBER DAM CLAMPS

Rubber dam clamps
Klamry do koferdamu



Fig. A
DR.905.001
Molars
do zębów trzonowych



Fig. AW
DR.905.002
Molars
do zębów trzonowych



Fig. BW
DR.905.003
Molars
do zębów trzonowych



Fig. C
DR.905.004
Incisors, canines and premolars
do zębów przednich i przedtrzonowych



Fig. DW
DR.905.005
Molars
do zębów trzonowych



Fig. E
DR.905.006
Incisors, canines and premolars
do zębów przednich i przedtrzonowych



Fig. EW
DR.905.007
Incisors, canines and premolars
do zębów przednich i przedtrzonowych



Fig. FW
DR.905.008
Molars
do zębów trzonowych



Fig. G
DR.905.009
Molars
do zębów trzonowych



Fig. GW
DR.905.010
Molars
do zębów trzonowych



Fig. HW
DR.905.011
Molars
do zębów trzonowych



Fig. JW
DR.905.012
Molars
do zębów trzonowych



Fig. K
DR.905.013
Molars
do zębów trzonowych



Fig. L
DR.905.014
Incisors, canines and premolars
do zębów przednich i przedtrzonowych



Fig. M
DR.905.015
Incisors, canines and premolars
do zębów przednich i przedtrzonowych



Fig. NW
DR.905.016
Molars
do zębów trzonowych



Fig. PW
DR.905.017
Molars
do zębów trzonowych

Premolars / do zębów przedtrzonowych



Fig. 00
DR.906.100



Fig. 0
DR.906.110



Fig. 1
DR.906.120



Fig. 2
DR.906.130



Fig. 2A
DR.906.140

Anteriors / do zębów przednich



Fig. 9
DR.906.090



Fig. 212
DR.906.212

Molars / do zębów trzonowych



Fig. 7
DR.906.530



Fig. 8
DR.906.550



Fig. 8A
DR.906.560



Fig. 14
DR.906.590



Fig. 14A
DR.906.600



**Restorative
Stomatologia zachowawcza**

**Rubber dam clamps tray
Tacka na klamry**



DR.904.010
Falcon

**Rubber dam template
Szablon do koferdamu**

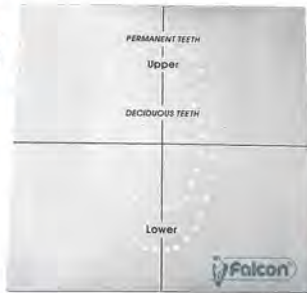

DR.948.000



Autoclavable
Możliwość sterylizacji w autoklawie

**Anatomical plastic rubber dam frame
Ramka do koferdamu anatomiczna, plastikowa**



Autoclavable
Możliwość sterylizacji w autoklawie



DR.937.020
For adult / Dla dorosłych

DR.937.030
For child / Dla dzieci

**Plastic flexible rubber dam frame
Ramka do koferdamu plastikowa**



Autoclavable
Możliwość sterylizacji w autoklawie



DR.937.040
For child / dla dzieci 98 x 74mm
DR.937.050
For adult / dla dorosłych, 148 x 102mm

**Rubber dam frames
Ramki do koferdamu**



Autoclavable
Możliwość sterylizacji w autoklawie



DR.938.130 130 mm
Young

DR.938.150 150 mm
Young



DR.937.000 150 mm
Falcon



DR.937.010
Falcon

**Plastic rubber dam frames
Ramka do koferdamu plastikowa**



Autoclavable
Możliwość sterylizacji w autoklawie



DR.937.060 85 x 105mm
Young



Rubber dam clamp forceps
Kleszce do klamer do koferdamu



Autoclavable
Możliwość sterylizacji w autoklawie

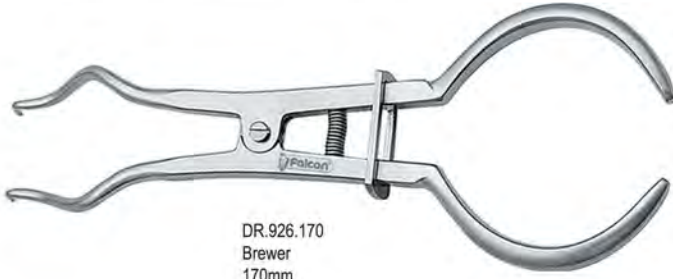

DR.926.170
Brewer
170mm



DR.928.170
IV
170mm



DR.929.170
Falcon
170mm



DR.931.170
Stokes
170mm



DR.932.170
Stokes/Palmer
170mm

Rubber dam punches
Dziurkacze do koferdamu



Autoclavable
Możliwość sterylizacji w autoklawie



DR.940.160
Ainsworth
160mm



DR.946.160
IV
160mm



Rubber dam instrument sets / Zestawy do koferdamu



DR.900.009
Contents/ Zawiera :

Rubber dam clamps
Klamry do koferdamu

Premolars / do zębów przedtrzonowych



Fig. 00
DR.906.100



Fig. 0
DR.906.110



Fig. 1
DR.906.120



Fig. 2
DR.906.130



Fig. 2A
DR.906.140

Anteriors / do zębów przednich



Fig. 9
DR.906.090



Fig. 212
DR.906.212

Molars / do zębów trzonowych



Fig. 7
DR.906.530



Fig. 8
DR.906.550



Fig. 8A
DR.906.560



Fig. 14
DR.906.590



Fig. 14A
DR.906.600

Rubber dam clamps tray
Tacka na klamry



DR.904.010
Falcon

Rubber dam frames
Ramki do koferdamu

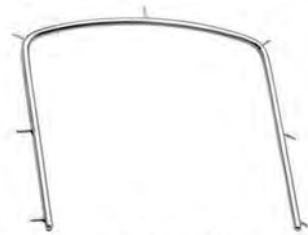

DR.938.130
Young
130 mm

Rubber dam clamp forceps
Kleszce do klamer do koferdamu



DR.928.170
IV
170mm

Rubber dam punches
Dziurkacze do koferdamu



DR.940.160
Ainsworth
160mm

Rubber dam template
Szablon do koferdamu

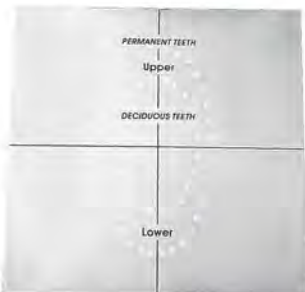

DR.948.000

Latex rubber dam
Koferdam z lateksu



DR.899.020
0.18
Medium / O średniej grubości

Green / Zielony
150 x 150 mm
36 sheets / 36 szt.

Sterilization cassettes / Kasetki do sterylizacji z zamkiem
Suitable for ultrasonic baths, disinfectors, autoclaves
Pasują do myjek ultradźwiękowych, dezynfektorów, autoklawów.



DZ.086.030
288 x 182x 34 mm



Autoclavable
Możliwość sterylizacji w autoklawie



Rubber dam instrument sets / Zestawy do koferdamu



DR.906.006
Contents/ Zawiera :



Autoclavable
Możliwość sterylizacji w autoklawie

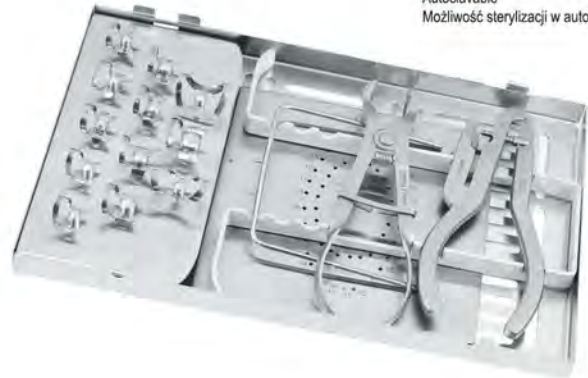

Rubber dam clamps
Klamry do koferdamu

Premolars / do zębów przedtrzonowych



Fig.00
DR.906.100



Fig.0
DR.906.110



Fig.1
DR.906.120



Fig.2
DR.906.130



Fig.2A
DR.906.140

Anteriors / do zębów przednich



Fig.9
DR.906.090



Fig.212
DR.906.212

Molars / do zębów trzonowych



Fig.7
DR.906.530



Fig.8
DR.906.550



Fig.8A
DR.906.560



Fig.14
DR.906.590



Fig.14A
DR.906.600

Rubber dam clamps tray
Tacka na klamry



DR.904.010
Falcon

Rubber dam frames
Ramki do koferdamu



DR.938.130 130 mm
Young

Rubber dam clamp forceps
Kleszki do klamer do koferdamu



DR.928.170
IV
170mm

Rubber dam punches
Dziurkacze do koferdamu

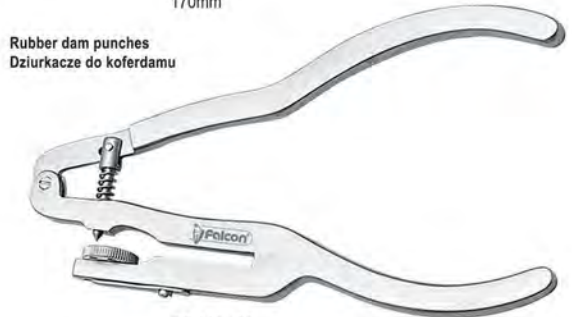

DR.946.160
IV
160mm

Rubber dam template
Szablon do koferdamu

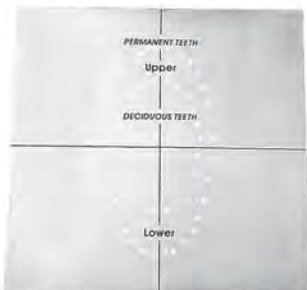

DR.948.000

Latex rubber dam
Koferdam z lateksu



DR.899.020
0.18
Medium / O średniej grubości

Green / Zielony
150 x 150 mm
36 sheets / 36 szt.

Sterilization cassettes / Kasetki do sterylizacji z zamkiem

Suitable for ultrasonic baths, disinfectors, autoclaves
Pasują do myjek ultradźwiękowych, dezynfektorów, autoklawów.



DZ.086.030
288 x 182x 34 mm



Rubber dam instrument sets / Zestawy do koferdamu



Autoclavable
Możliwość sterylizacji w autoklawie



DR.900.007
Contents/ Zawiera :



Rubber dam clamps
Klamry do koferdamu



Fig. A
DR.905.001
Molars
do zębów trzonowych



Fig. C
DR.905.004
Incisors, canines and premolars
do zębów przednich i przedtrzonowych



Fig. E
DR.905.006
Incisors, canines and premolars
do zębów przednich i przedtrzonowych



Fig. FW
DR.905.008
Molars
do zębów trzonowych



Fig. G
DR.905.009
Molars
do zębów trzonowych



Fig. K
DR.905.013
Molars
do zębów trzonowych



Fig. L
DR.905.014
Incisors, canines and premolars
do zębów przednich i przedtrzonowych



Fig. M
DR.905.015
Incisors, canines and premolars
do zębów przednich i przedtrzonowych

Rubber dam clamps tray
Tacka na klamry



DR.904.010
Falcon

Rubber dam frames
Ramki do koferdamu

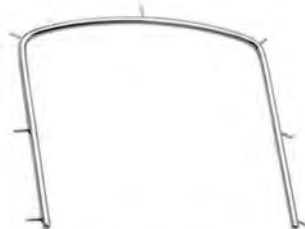

DR.938.130 130 mm
Young

Rubber dam clamp forceps
Kleszce do klamer do koferdamu

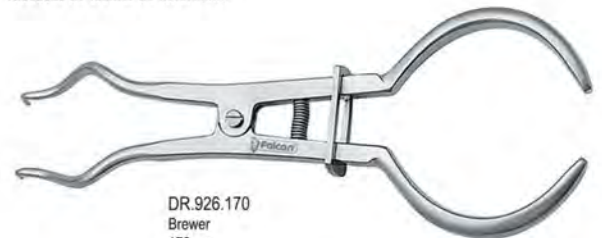

DR.926.170
Brewer
170mm

Rubber dam punches
Dziurkacze do koferdamu



DR.940.160
Ainsworth
160mm

Rubber dam template
Szablon do koferdamu

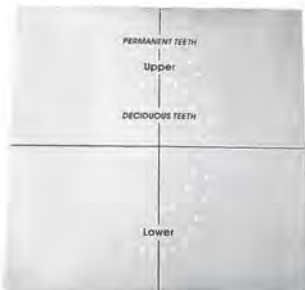

DR.948.000

Latex rubber dam
Koferdam z lateksu



DR.899.020
0,18
Medium / O średniej grubości

Green / Zielony
150 x 150 mm
36 sheets / 36 szt.

Sterilization cassettes / Kasetki do sterylizacji z zamkiem
Suitable for ultrasonic baths, disinfectors, autoclaves
Pasują do myjek ultradźwiękowych, dezynfektorów, autoklawów.



DZ.086.030
288 x 182x 34 mm



Biuro i Magazyn

Falcon Medical Polska sp z o.o.
93-575 Łódź, ul. Rembielińskiego 1/7
Poland
Tel: +48 42 630 99 72
Fax: +48 42 630 99 73
www.falconmedical.pl

Sklep firmowy

Sklep Stomatologiczno Medyczny
Al. Kościuszki 32, 90-419 Łódź
Poland
Tel: +48 42 632 20 01
Fax: +48 42 632 20 01